

宁波奇明机械制造有限公司  
Ningbo Qiming Machinery Manufacturing Co.,Ltd.

Helen Jiang

WhatsApp/Mobile:0086 13812859969

Email:sales02@bottleblow.cn

Website:www.mepermachine.com



Wechat

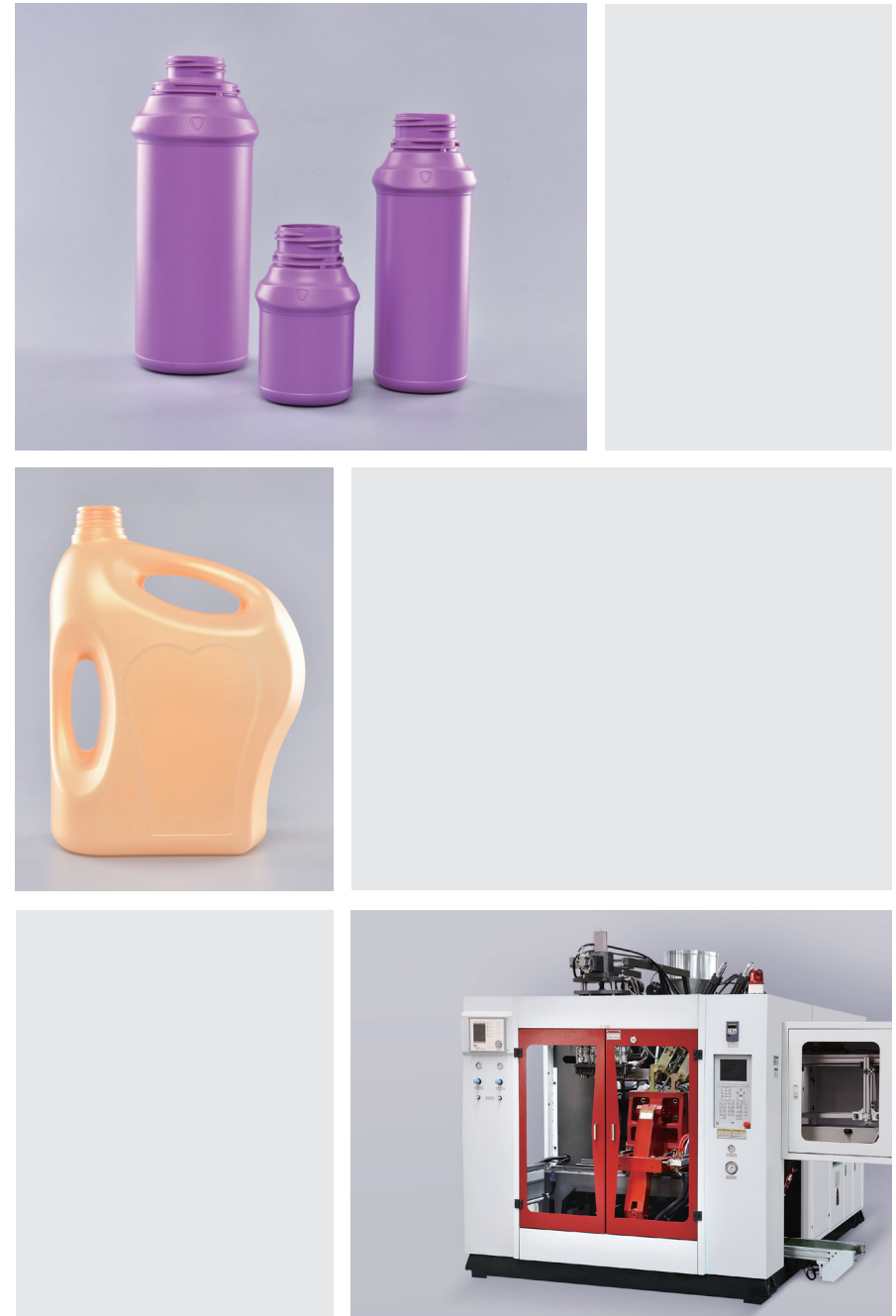





## 我们热爱机械，我们热爱塑料。

MEPER 公司的员工们都执着于追求创新的塑料机械科技，为众多的客户提供关于挤出吹塑成型领域的智能解决方案。我们的目标是与合作伙伴的进步而制造领先的自动化设备。

我们成立于经济蓬勃发展初期的 1998 年。位于中国的塑料机械之都—宁波市。拥有 10000 平方米以上的工作厂区与 100 多名员工。其中，绝大多数为经验丰富并且专业的技术设计及服务人员。

发展至今，MEPER 公司已成功交付超过 2000 台设备于全球客户使用。并且已在全球 5 大洲建立快速服务团队。我们能够为客户提供充足的支持与交流。

## Machinery and plastics are all our passion.

At MEPER, we all are dedicated to innovating advanced plastic machinery technology and creating intelligent extrusion blow molding solution. We aim to create added value and progress for our partners and customers.

The company was founded in 1998 in Ningbo, China. It is the center of Chinese plastic machinery. As pioneer in the field, we have over 10,000 square meters working area and over 100 employees. The majority of our staffs are in the profession of design, manufacturing and service.

Currently, MEPER has successfully delivered and installed more than 2,000 sets of extrusion blow molding machines worldwide. Moreover, we have established quick-response service teams and partners in 5 major continents. We are always ready to stay close with our customers wherever you are.

为合作伙伴的进步而制造

# MANUFACTURING PROGRESS THROUGH PARTNERSHIP



# 产品应用 Area of Application

09 10

产品应用  
Area of Application

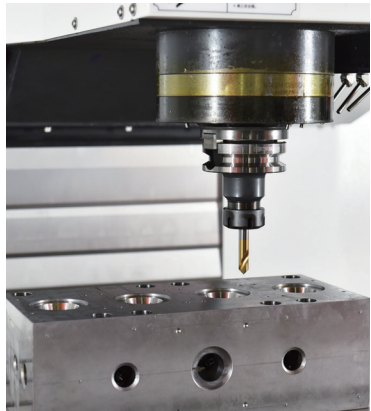

我们拥有  
强大的挤出技术

—  
WE HAVE  
POWERFUL  
EXTRUSION  
TECHNOLOGY

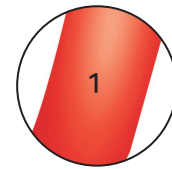
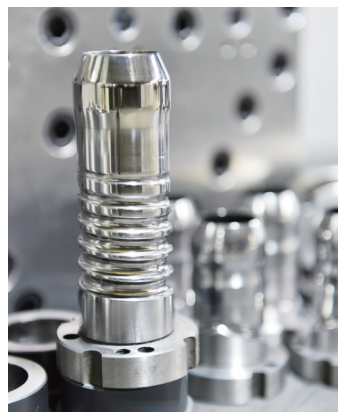
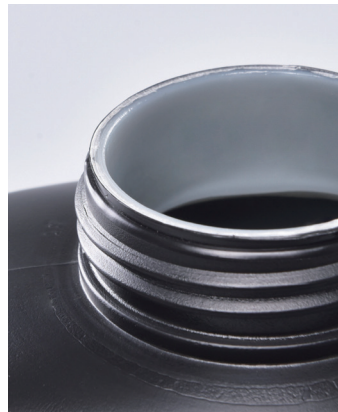

## Mono-Layer

- 1. Virgin & Color
- 1. 新料 + 色母

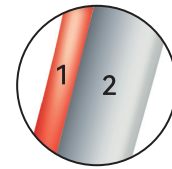

## DeCo

- 1. Outer Layer - Virgin & Color
- 1. 外层 - 新料 + 色母
- 2. Inner Layer - Virgin & Re grind
- 2. 内层 - 新料 + 回收料

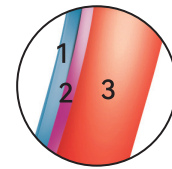

## CoEx 3

- 1. Outer Layer - Barrier (EVOH / Nylon)
- 1. 外层 - 阻隔料
- 2. Tie Layer - Adhesive
- 2. 中间层 - 粘合剂
- 3. Inner Layer - Virgin & Color
- 3. 内层 - 新料 + 色母

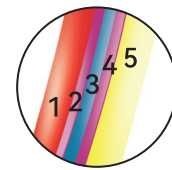

## CoEx 5

- 1. Outer Layer - Virgin
- 1. 外层 - 新料
- 2. Tie Layer - Adhesive
- 2. 粘合层
- 3. Barrier Layer (EVOH)
- 3. 阻隔层 - EVOH/PA
- 4. Tie Layer - Adhesive
- 4. 粘合层
- 5. Inner layer - Virgin
- 5. 内层 - 新料

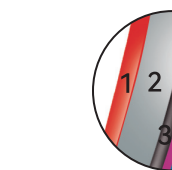

## CoEx 7

- 1. Outer Layer - Virgin & Color
- 1. 外层 - 新料 + 色母
- 2. Virgin & Re grind
- 2. 新料 + 回收料
- 3. UV Barrier - Virgin & Black Color
- 3. UV 阻隔层 - 新料 + 黑色色母
- 4. Tie Layer - Adhesive
- 4. 粘合层
- 5. Barrier Layer (EVOH)
- 5. 阻隔层 - EVOH/PA
- 6. Tie Layer - Adhesive
- 6. 粘合层
- 7. Inner layer - Virgin
- 7. 内层 - 新原料

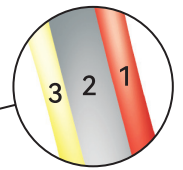

## ReCo

- 1. Outer Layer - Virgin & Color
- 1. 外层 - 新料 + 色母
- 2. Middle Layer - e.g. PCR & Re grind
- 2. 中间层 - PCR + 回收料
- 3. Inner Layer - Virgin
- 3. 内层 - 新料

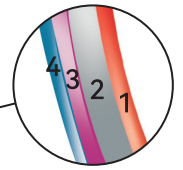

## CoEx 4

- 1. Outer Layer - Virgin
- 1. 外层 - 新料 + 色母
- 2. Virgin & Re grind
- 2. 新料 + 回收料
- 3. Tie Layer - Adhesive
- 3. 粘合层
- 4. Inner Layer - Barrier
- 4. 阻隔层 - EVOH/PA

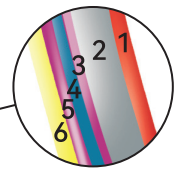

## CoEx 6

- 1. Outer Layer - Virgin & Color
- 1. 外层 - 新料 + 色母
- 2. Re grind Layer - Virgin & Re grind
- 2. 新料 + 回收料
- 3. Tie Layer - Adhesive
- 3. 粘合层
- 4. Barrier Layer (EVOH)
- 4. 阻隔层 - EVOH/PA
- 5. Tie Layer - Adhesive
- 5. 粘合层
- 6. Inner layer - Virgin
- 6. 内层 - 新料

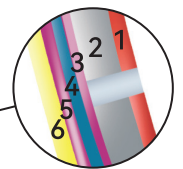

## CoEx 6 with viewstripe

A viewstripe is available from monolayer to CoEx7 without affecting barrier layer coverage.

液位线可以适用与所有模头设计

# 自动吹塑中空成型机 MP55/70/80D

11 12

自动吹塑中空成型机  
Products

我们热爱机械，我们热爱塑料。

MEPER 公司的员工们都执着于追求创新的塑料机械科技，为众多的客户提供关于挤出吹塑成型领域的智能解决方案。我们的目标是为客户的进步而制造领先的自动化设备。

我们成立于经济蓬勃发展初期的 1998 年。位于中国的塑料机械之都—宁波市。拥有 10000 平米以上的工作厂区与 100 多名员工。其中，绝大多数为经验丰富并且专业的技术设计及服务人员。

发展至今，MEPER 公司已成功交付超过 2000 台设备于全球客户使用。并且已在全球 5 大洲建立快速服务团队。我们能够为客户提供充足的支持与交流。

Machinery and plastics are all our passion.

At MEPER, we all are dedicated to innovating advanced plastic machinery technology and creating intelligent extrusion blow molding solution. We aim to create added value and progress for our partners and customers.

The company was founded in 1998 in Ningbo, China. It is the center of Chinese plastic machinery. As pioneer in the field, we have over 10,000 square meters working area and

over 100 employees. The majority of our staffs are in the profession of design, manufacturing and service.

Currently, MEPER has successfully delivered and installed more than 2,000 sets of extrusion blow molding machines worldwide. Moreover, we have established quick-response service teams and partners in 5 major continents. We are always ready to stay close with our customers wherever you are.



产品参数 Product Parameters

机头 Die Head	单		双		叁	
示意图 Example						
机型 Model	中心距 CD (mm)	制品容量 Volume (L)	中心距 CD (mm)	制品容量 Volume (L)	中心距 CD (mm)	制品容量 Volume (L)
MP55D	/	2	140	1	100	0.5
MP70D	/	5	160	2	120	1
MP80D	/	10	200	3	150	1.5
机头 Die Head	肆		伍		陆	
示意图 Example						
机型 Model	中心距 CD (mm)	制品容量 Volume (L)	中心距 CD (mm)	制品容量 Volume (L)	中心距 CD (mm)	制品容量 Volume (L)
MP55D	75	0.2	60	0.1	50	0.02
MP70D	100	0.5	70	0.1	60	0.05
MP80D	110	1	80	1	70	0.1

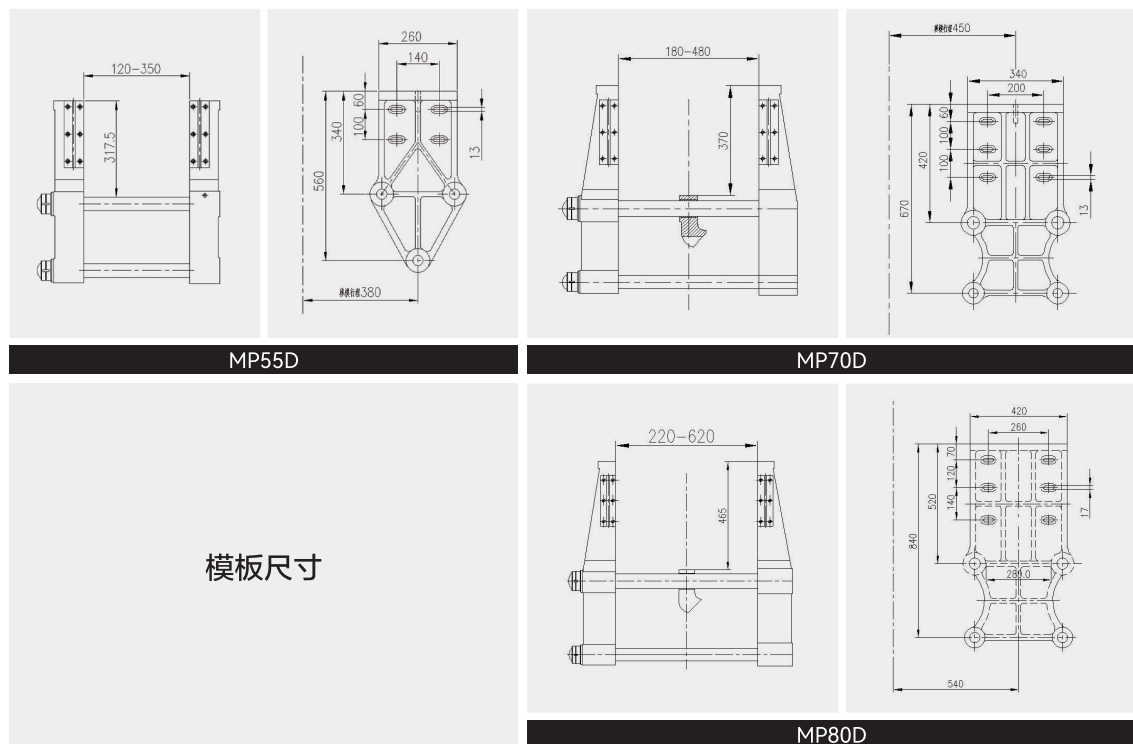

# 自动吹塑中空成型机 MP70/80/100FD

15 16

自动吹塑中空成型机  
Products

我们热爱机械，我们热爱塑料。

MEPER 公司的员工们都执着于追求创新的塑料机械科技，为众多的客户提供关于挤出吹塑成型领域的智能解决方案。我们的目标是为合作伙伴的进步而制造领先的自动化设备。

我们成立于经济蓬勃发展初期的 1998 年。位于中国的塑料机械之都—宁波市。拥有 10000 平米以上的工作厂区与 100 多名员工。其中，绝大多数为经验丰富并且专业的技术设计及服务人员。

发展至今，MEPER 公司已成功交付超过 2000 台设备于全球客户使用。并且已在全球 5 大洲建立快速服务团队。我们能够为客户提供充足的支持与交流。

Machinery and plastics are all our passion.

At MEPER, we all are dedicated to innovating advanced plastic machinery technology and creating intelligent extrusion blow molding solution. We aim to create added value and progress for our partners and customers.

The company was founded in 1998 in Ningbo, China. It is the center of Chinese plastic machinery. As pioneer in the field, we have over 10,000 square meters working area and

over 100 employees. The majority of our staffs are in the profession of design, manufacturing and service.

Currently, MEPER has successfully delivered and installed more than 2,000 sets of extrusion blow molding machines worldwide. Moreover, we have established quick-response service teams and partners in 5 major continents. We are always ready to stay close with our customers wherever you are.

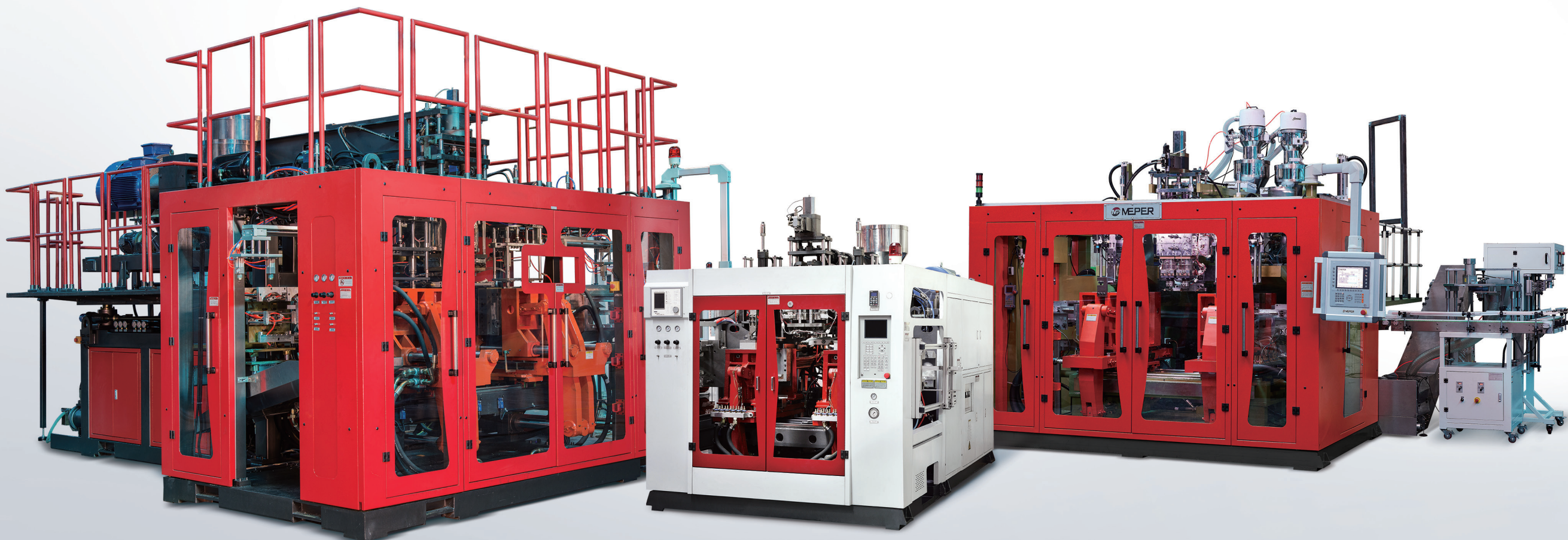

产品参数 Product Parameters

机头 Die Head	单		双		叁	
示意图 Example						
机型 Model	中心距 CD (mm)	制品容量 Volume (L)	中心距 CD (mm)	制品容量 Volume (L)	中心距 CD (mm)	制品容量 Volume (L)
MP55FD	/	2	140	1	100	0.5
MP70FD	/	5	160	2	120	1
MP80FD	/	10	200	3	150	1.5
MP90FD	/	15	240	4	160	2
MP100FD	/	20	280	5	200	3
机头 Die Head	肆		伍		陆	
示意图 Example						
机型 Model	中心距 CD (mm)	制品容量 Volume (L)	中心距 CD (mm)	制品容量 Volume (L)	中心距 CD (mm)	制品容量 Volume (L)
MP55FD	75	0.2	60	0.1	50	0.02
MP70FD	100	0.5	70	0.1	60	0.05
MP80FD	110	1	80	1	70	0.1
MP90FD	120	1.5				
MP100FD	150	2				

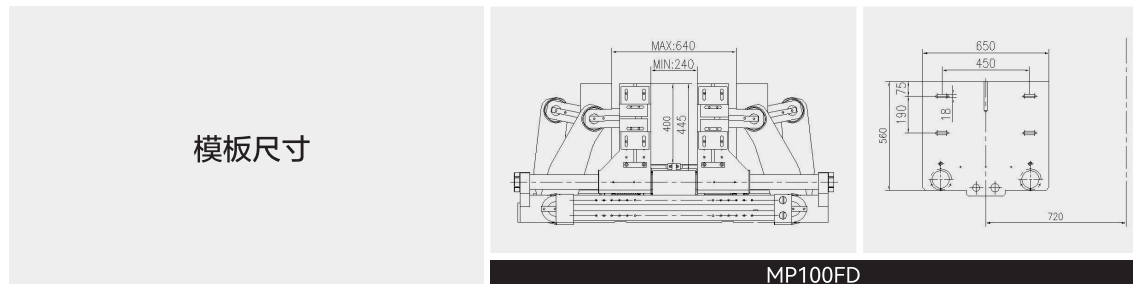
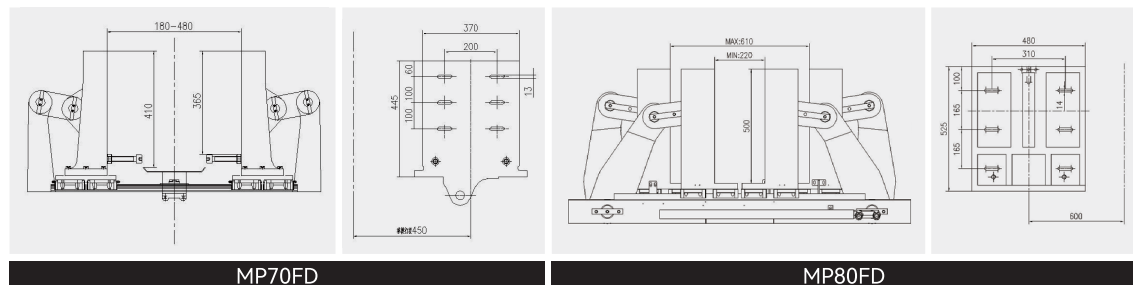

# 自动吹塑中空成型机 MP70/80/90FS

19 20

自动吹塑中空成型机  
Products

我们热爱机械，我们热爱塑料。

MEPER 公司的员工们都执着于追求创新的塑料机械科技，为众多的客户提供关于挤出吹塑成型领域的智能解决方案。我们的目标是为合作伙伴的进步而制造领先的自动化设备。

我们成立于经济蓬勃发展初期的 1998 年。位于中国的塑料机械之都—宁波市。拥有 10000 平米以上的工作厂区与 100 多名员工。其中，绝大多数为经验丰富并且专业的技术设计及服务人员。

发展至今，MEPER 公司已成功交付超过 2000 台设备于全球客户使用。并且已在全球 5 大洲建立快速服务团队。我们能够为客户提供充足的支持与交流。

Machinery and plastics are all our passion.

At MEPER, we all are dedicated to innovating advanced plastic machinery technology and creating intelligent extrusion blow molding solution. We aim to create added value and progress for our partners and customers.

The company was founded in 1998 in Ningbo, China. It is the center of Chinese plastic machinery. As pioneer in the field, we have over 10,000 square meters working area and

over 100 employees. The majority of our staffs are in the profession of design, manufacturing and service.

Currently, MEPER has successfully delivered and installed more than 2,000 sets of extrusion blow molding machines worldwide. Moreover, we have established quick-response service teams and partners in 5 major continents. We are always ready to stay close with our customers wherever you are.



产品参数 Product Parameters

机头 Die Head	单		双		叁	
示意图 Example						
机型 Model	中心距 CD (mm)	制品容量 Volume (L)	中心距 CD (mm)	制品容量 Volume (L)	中心距 CD (mm)	制品容量 Volume (L)
MP70FS	/	10	200	4	150	1
MP80FS	/	20	250	5	200	2
MP90FS	/	30	300	10	250	5
机头 Die Head	肆		陆		捌	
示意图 Example						
机型 Model	中心距 CD (mm)	制品容量 Volume (L)	中心距 CD (mm)	制品容量 Volume (L)	中心距 CD (mm)	制品容量 Volume (L)
MP70FS	120	1	80	0.5	60	02
MP80FS	140	1.5	125	1	100	05
MP90FS	200	2	140	1	125	1

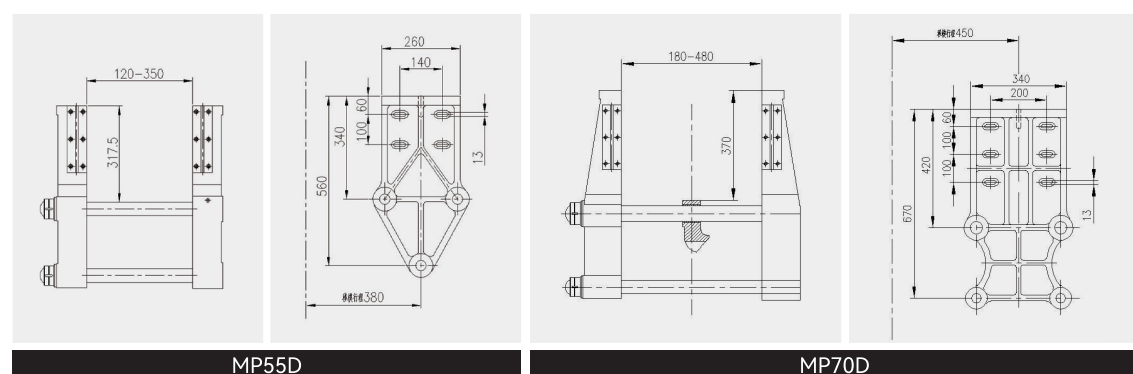

MP55D

MP70D

模板尺寸

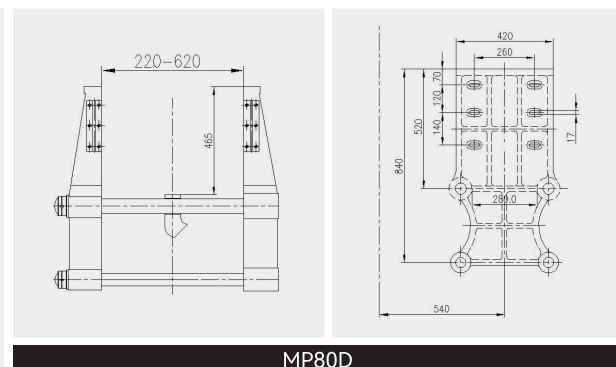

MP80D

